

saheco

SF-30D

CON GUIADOR

Poligono Industrial Foradada - 08580 - Sant Quirze de Besora (Barcelona)

Telf. 34-93.852.92.23, Fax. 34-93.852.91.76

e-mail: saheco@saheco.com

web: www.saheco.com

**GRUPO
TORREMAT**

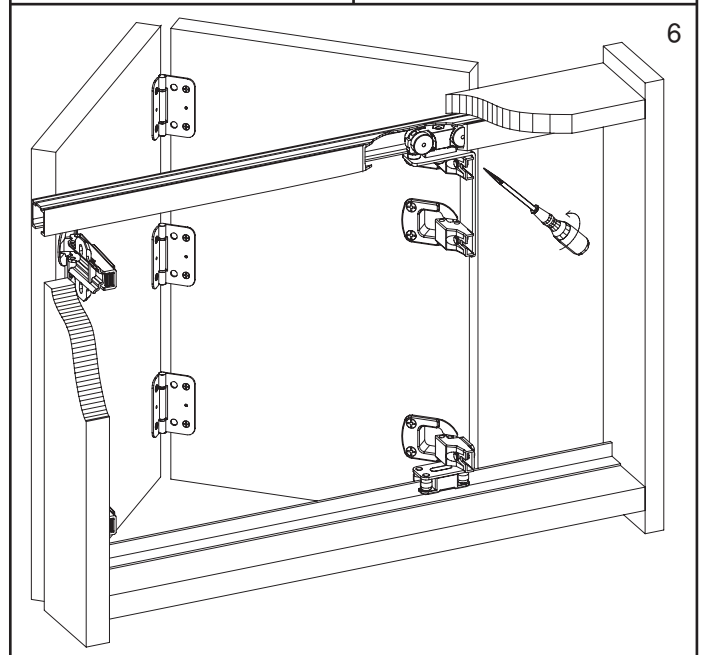
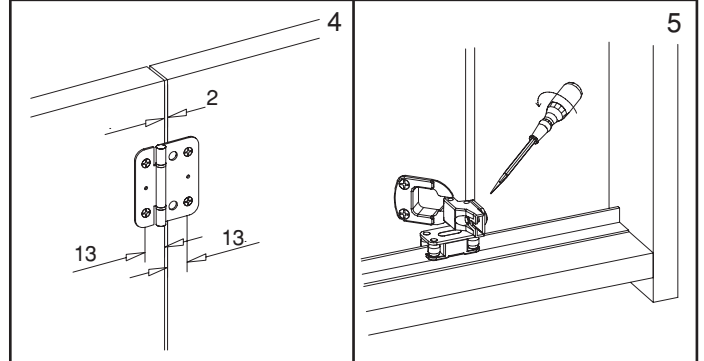
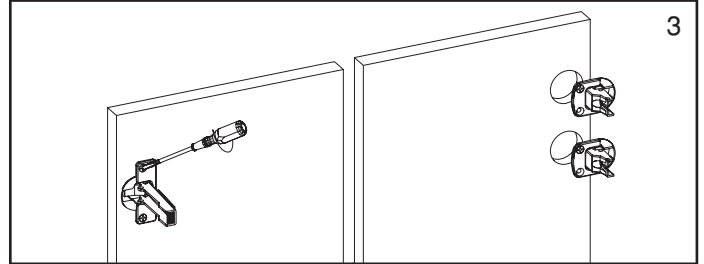
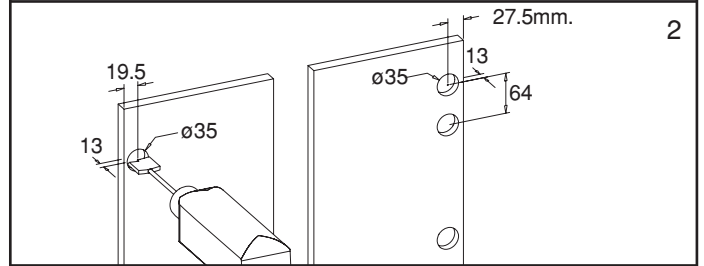
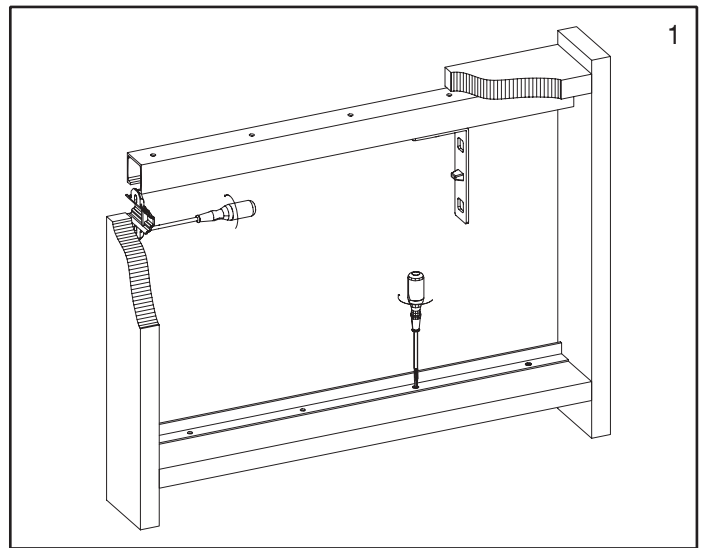
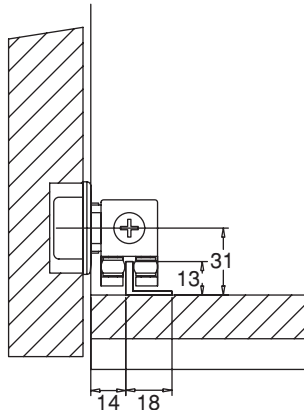
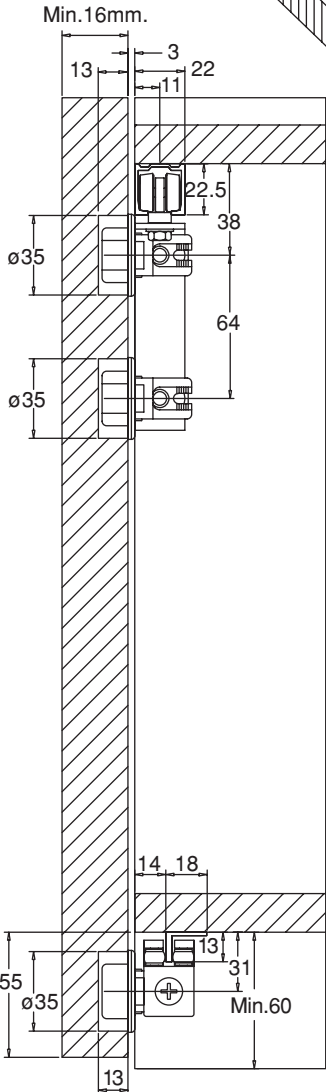
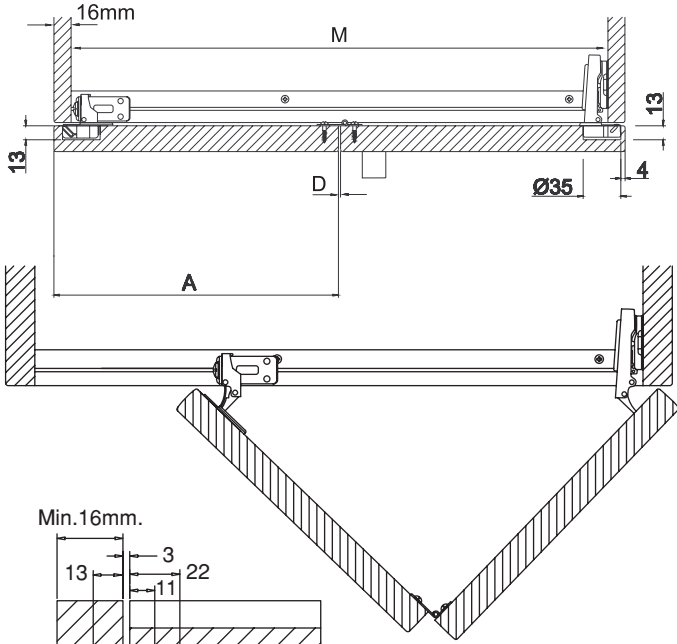

038060052

صنع في السوق الأوروبية

MADE IN SPAIN

FORMULARIO HOJAS PLEGABLES PARA MUEBLES Y ARMARIO

FOLDING DOORS FORMULARY FOR FURNITURE AND CUPBOARDS
 FORMULAIRE POUR PORTES PLIANTES POUR MEUBLES ET CABINET

CERRAMIENTO ABIERTO POR UN LADO

CLOSING OPENING FOR ONE SIDE
 ENCLOS OUVERT PAR UNE CÔTÉ

FÓRMULA ANCHO HOJAS

FORMULA WIDE LEAVES
 FORMULE LARGE FEUILLES

$$A = \frac{M + 32 - D}{2}$$

LEYENDA

LEGEND
 LÉGENDE

A= ANCHO HOJAS / WIDE LEAVES / LARGE FEUILLES

M= ANCHO DE LUZ TOTAL / OVERALL WIDTH / LARGUEUR TOTAL

D= SEPARACIÓN BISAGRAS = 2mm / HINGES SEPARATION = 2mm /
 SÉPARATION CHARNIÈRE = 2mm

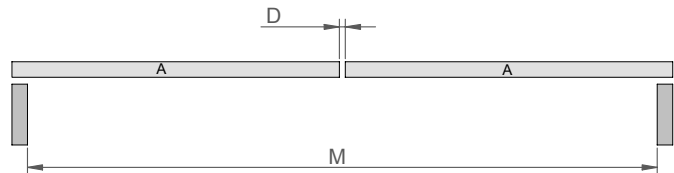

EJEMPLO / EXAMPLE / EXEMPLE

M	1000
D	2

$$A = \frac{1000 + 32 - 2}{2} \rightarrow A = 515\text{mm}^*$$

*REDONDEAR AL ENTERO INFERIOR/TO ROUND TO THE WHOLE NUMBER INFERIOR / ARRONDIR À L'INFÉRIEUR COMPLET

CERRAMIENTO ABIERTO POR EL CENTRO

CLOSING OPENING FOR THE CENTER
 ENCLOS OUVERT PAR LE CENTRE

FÓRMULA ANCHO HOJAS

FORMULA WIDE LEAVES
 FORMULE LARGE FEUILLES

$$A = \frac{M + 32 - 2D - F}{4}$$

LEYENDA

LEGEND
 LÉGENDE

A= ANCHO HOJAS / WIDE LEAVES / LARGE FEUILLES

M= ANCHO DE LUZ TOTAL / OVERALL WIDTH / LARGUEUR TOTAL

D= SEPARACIÓN BISAGRAS = 2mm / HINGES SEPARATION = 2mm /
 SÉPARATION CHARNIÈRE = 2mm

F= SEPARACION FINAL = 4mm / FINAL SEPARATION = 4mm / SÉPARATION
 FINALE = 4mm

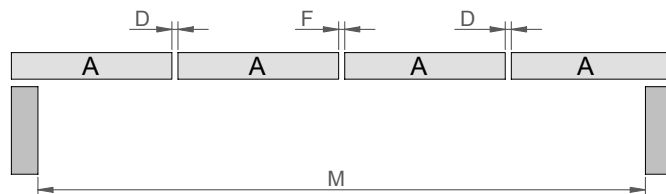

EJEMPLO / EXAMPLE / EXEMPLE

M	2000
D	2
F	4

$$A = \frac{2000 + 32 - 2 \cdot 2 - 4}{4} \rightarrow A = 506\text{mm}^*$$

*REDONDEAR AL ENTERO INFERIOR/TO ROUND TO THE WHOLE NUMBER INFERIOR / ARRONDIR À L'INFÉRIEUR COMPLET

FORMULARIO HOJAS PLEGABLES PARA MUEBLES Y ARMARIO

FOLDING DOORS FORMULARY FOR FURNITURE AND CUPBOARDS
 FORMULAIRE POUR PORTES PLIANTES POUR MEUBLES ET CABINET

FÓRMULA ALTO HOJAS - MONTAGE INFERIOR DEL GUIADOR

FORMULA HEIGHT LEAVES - ASSEMBLY INFERIOR OF THE GUIDE
 FORMULE HAUT FEUILLES - ASSEMBLAGE INFÉRIEUR DU GUIDE

LEYENDA

LEGEND
 LÉGENDE

$$A = Z + X + 60$$

A= ALTO HOJAS / HIGH LEAVES / HAUT FEUILLES

X= ALTO DE LUZ TOTAL / OVERALL HEIGHT / HAUTEUR TOTALE

Z= HOLGURA SUPERIOR / COMFORT SUPERIOR / PLAISIR SUPÉRIEUR

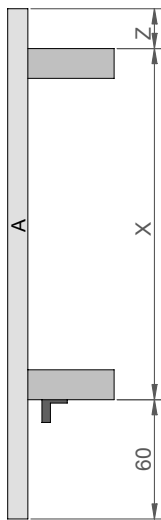

EJEMPLO / EXAMPLE / EXEMPLE

X	1000
Z	20

$$A = 20 + 1000 + 60 \rightarrow A = 1080\text{mm}$$

FÓRMULA ALTO HOJAS - MONTAGE SUPERIOR DEL GUIADOR

FORMULA HEIGHT LEAVES - ASSEMBLY SUPERIOR OF THE GUIDE
 FORMULE HAUT FEUILLES - ASSEMBLAGE SUPÉRIEUR DU GUIDE

LEYENDA

LEGEND
 LÉGENDE

$$A = Z + X + Y$$

A= ALTO HOJAS / HIGH LEAVES / HAUT FEUILLES

X= ALTO DE LUZ TOTAL / OVERALL HEIGHT / HAUTEUR TOTALE

Z= HOLGURA SUPERIOR / COMFORT SUPERIOR / PLAISIR SUPÉRIEUR

Y= HOLGURA INFERIOR / COMFORT INFERIOR / PLAISIR INFÉRIEUR

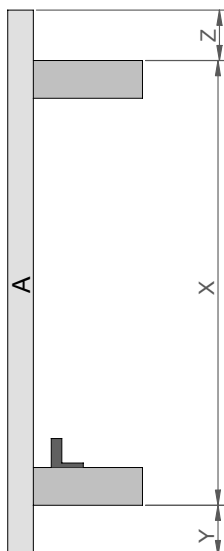

EJEMPLO / EXAMPLE / EXEMPLE

X	1000
Y	15
Z	20

$$A = 1000 + 20 + 15 \rightarrow A = 1035\text{mm}$$